



Wired and Wireless Addressable Fire Alarm Control Panel

User Manual



1008-CPR-MC 69266873 0001
EN 54-2:1997+A1:2006

Version: 1.1.2

Date: October 23rd, 2023



ASENWARE LTD

Website: www.asenware.com

Email: info@asenware.com

Manufacturer: **Zhongshan Guta Fire Equipment Technology Co.,Ltd**

Add: 4/F,#10,Xingye Rd, Huoju District Zhongshan City,Guangdong P.R. China.

Applicable model

AW-FP20x,

(x = 0,1,2,3,4,5,6,7,8)



ASENWARE LTD

Website: www.asenware.com

Email: info@asenware.com

Manufacturer: **Zhongshan Guta Fire Equipment Technology Co.,Ltd**

Add: 4/F,#10,Xingye Rd, Huoju District Zhongshan City,Guangdong P.R. China

Version description

Version	Description	Date
V1.0	First established.	Nov 10th, 2022
V1.01	Modify text description.	Mar 3 rd , 2023
V1.10	Modify USB description	Aug 9 th , 2023
V1.11	Modify parameters.	Sep 27 th , 2023
V1.12	Add TÜV Label	Oct 23 rd , 2023



ASENWARE LTD

Website: www.asenware.com

Email: info@asenware.com

Manufacturer: **Zhongshan Guta Fire Equipment Technology Co.,Ltd**

Add: 4/F,#10,Xingye Rd, Huoju District Zhongshan City,Guangdong P.R. China

1 Product specification

1.1 Overview

The AW-FP20x series addressable fire alarm control panel is designed with 7-inch LCD display touch screen with button operation, easy to operate, and nice human-computer interface.

This machine can be connected to 8 loops. Each loop can be connected to 250 devices, such as smoke detectors, temperature detectors, input/output modules, each loop can be connected to 10 groups of wireless loops, a group of wireless loops can be connected to 20 devices, such as smoke detector, temperature detector, input and output module, etc.

Two kinds of configuration equipment test.

1. the host hand, automatic registration of all the equipment in the wired loop.
 2. The computer software configures the device status.
- 8 hosts CAN communicate with each other for remote control.

Mobile phone GSM to receive alarm information.

The equipment in each zone can be individually set up a linkage group, and when a device alarms, it can be activated by strobe according to the Zone Link Group setting. All devices can be configured to different zones independently to activate the zones be interconnected.

1.2 Features:

- 1.2.1 7 inch color LCD display, touch screen operation.
- 1.2.2 All addressable devices use a two-wire system.
- 1.2.3 A wired loop can connect 250 wired addressable devices, including 10 groups of wireless loops.
- 1.2.4 One set of wireless loops can connect to 20 devices.
- 1.2.5 Max 8 loop cards can be installed.
- 1.2.6 Up to 999 records of history can be saved (save when power off).
- 1.2.7 Multiple access levels can be set.
- 1.2.8 It has a rechargeable backup battery.
- 1.2.9 Can simply judge the running status of the machine based on the LED lights.
- 1.2.10 Automatic search device.
- 1.2.11 Each of the 8 hosts CAN be controlled remotely.
- 1.2.12 USB software upper computer to check and set the device status and fire history records.



ASENWARE LTD

Website: www.asenware.com

Email: info@asenware.com

Manufacturer: **Zhongshan Guta Fire Equipment Technology Co.,Ltd**

Add: 4/F,#10,Xingye Rd, Huoju District Zhongshan City,Guangdong P.R. China

1.2.13 It can bind 10 mobile phone numbers to receive host alarm information. (The GSM module must be added)

1.3 LCD Display Screen Introduction

LCD display screen: It is used to display all alarm information and configuration information of all current systems, and can set various contents of the system through touch screen.

1.4 LED Indicator Status Specification

Indicator Name	Colour	Status specification
Fire Alarm	Red	When there is a fire alarm, the light will be on
Pre-Alarm	Red	When the pre-alarm, the indicator will be on
General Fault	Yellow	This indicator will be on when there is any malfunction in the system.
System Fault	Yellow	When the panel program or memory fails, the indicator will be on (Note: The failure will be locked until the reset key is pressed).
Mains Fault	Yellow	When the mains fails, the indicator will be on
Batter Fault	Yellow	When the batter fails, the indicator will be on
Fuse Fault	Yellow	When the fuse fails, the indicator will be on
Earth Fault	Yellow	When the earth fails, the indicator will be on
Power	Green	When the panel works, the power indicator will be on.
Delay	Red	When the panel is waiting for the alarm delay, the power indicator will be on.
General Disable	Yellow	This indicator will be on when the panel has a disabled device.
AUX Power Fault	Yellow	When the AUX Power fails, the indicator will be on
F.A Output Activated	Red	When the F.A Output Activated, the indicator will be on
F.P.E Output Activated	Red	When the F.P.E Output Activated, the indicator will be on
S.C Output Activated	Red	When the S.C Output Activated, the indicator will be on
Supervisory	Green	When the system detects any Supervisory information, the indicator will be on.
Rest	Green	When after pressing the reset button, the indicator will be on, turns off after reset is complete
Evacuate	Red	When the system is in an evacuation state, the light will



ASENWARE LTD

Website: www.asenware.com





Email: info@asenware.com



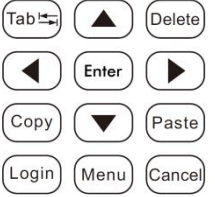

Manufacturer: **Zhongshan Guta Fire Equipment Technology Co.,Ltd**

Add: 4/F,#10,Xingye Rd, Huoju District Zhongshan City,Guangdong P.R. China

		be on.
Panel Buzzer Silence	Yellow	This indicator will be on when the panel is silent.
Remote Sounder Silence	Yellow	This indicator will be on when the panel is silenced remotely.
F.A Output Disabled	Yellow	When the F.A Output disabled, the indicator will be on
F.P.E Output Fault/Disabled	Yellow	When the F.P.E Output disabled, the indicator will be on. When the F.P.E Output Fault, the indicator will be flashing.
S.C Output Fault/Disabled	Yellow	When the S.C Output disabled, the indicator will be on. When the S.C Output Fault, the indicator will be flashing.
Test	Green	When the test button is pressed, the light will be on until the test is completed.

1.5 Button Introduction

Key	Description
	Reserves.
	Reserves.
	Evacuate: Activate all output device (change in Register)
	Disable/Enable F.A Output
	Disable/Enable F.P.E Output
	Disable/Enable S.C Output

	Silence Buzzer on Panel
	Silence S.C Output and all sounder devices (such as horn strobe and bell)
	Reset the panel, and clean all alarm.
	Run LED.

1. 6 Electrical Parameters

Rated input voltage	220~240Va.c. 50Hz/60Hz	
Standby battery	Two 12V/7Ah lead-acid batteries in series	
Work environment	Relative humidity (<95%) at -10 ~45 °C, no condensation)	
Fuse	AC power input fuse	3.15A/250V 5*20mm ,Glass tube fuse slowly blow
	Battery output fuse	10A/250V 5*20mm , Glass tube fuse ,slowly blow
Auxiliary power supply	Resettable 24VDC 200mA (Max)	
F.A output	Relay, normal open with NO - COM, and will close when fire alarm.	
Fault output	Relay, normal open with NO - COM, and will close when fault.	
F.P.E output	Normal state output - 12VDC, Fire alarm state output - 24VDC/200mA (Max)	
S.C output	Normal state output - 12VDC, Active state output - 24VDC/200mA (Max)	
Maximum Load Current per Loop	24VDC 3A(Max)	
Wireless Frequency	433MHz	
Terminal blocks rating	All terminals rated for 12 to18 AWG(0.75 to 2.5 mm ²) Screened or unscreened twisted-pair, Transmission distance ≤1000m	

1.7 Mounting

1.7.1 Notice

- 1.7.1.1 The panel should be installed on the dry, flat wall, keep in line of sight height and horizontal position to ensure the balance of the external chassis. Install the panel in three fixed positions using bolts or bolts with a diameter of 6mm(M6).
- 1.7.1.2 The panel should not be installed in sealed environments or near heaters. Appropriate insulated cables should be used in the corresponding positions. If additional cable entry points are required, all debris and debris generated by drilling holes must be removed before the panel is energized.
- 1.7.1.3 Preparations: Make sure the installation location is free of construction dust, debris, extreme temperature range and humidity.
- 1.7.1.4 The ground wire is then connected to the AC power supply. We recommend 16AWG to the AC power supply.
- 1.7.1.5 Before connecting the power cord to the panel, make sure that the total power supply has been disconnected. Do not operate live.
- 1.7.1.6 Before use, the LOOP corresponding to the LOOPCARD board should be selected with the jumper cap, and the selection method is on the back of the loop card board (the loop can only be selected from 1 to 8). Prohibit two or more LOOPCARDS from selecting the same LOOP.
- 1.7.1.7 Before connecting the backup battery, the FP20x should be connected to the main power supply.

**ASENWARE LTD**Website: www.asenware.comEmail: info@asenware.comManufacturer: **Zhongshan Guta Fire Equipment Technology Co.,Ltd**

Add: 4/F,#10,Xingye Rd, Huoju District Zhongshan City,Guangdong P.R. China

1.7.2 Panel side view, front view and mounting diagram

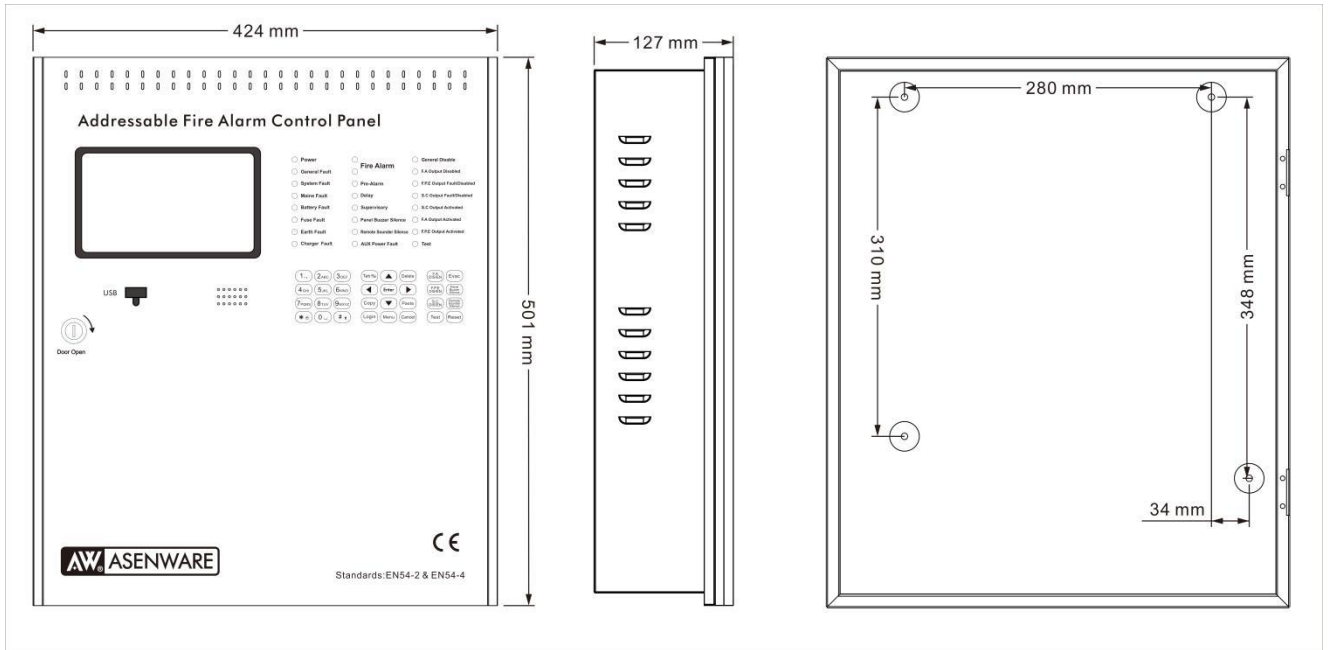

Front view

Side view

Mounting diagram

2 Terminals Specification

2.1 AC Power connection

Note: before wiring, please ensure that all power is disconnect to prevent electric shock !

Connecting the AC power cable to the panel, pay attention to the order of L/N/E, insert it into three pin terminals (5mm apart) and screw up. Wires must be between 0.75 and 2.5 mm².

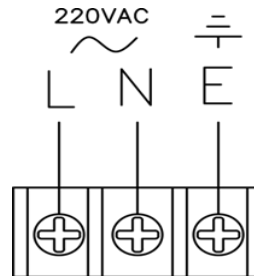

2.2 FAULT OUTPUT

This terminal is wiring to other external alarm devices.

This terminal is in normally closed mode under normal conditions, and COM-NC is closed. If there is a fault alarm output, it will switch to the normally open mode and COM-NO will be closed.

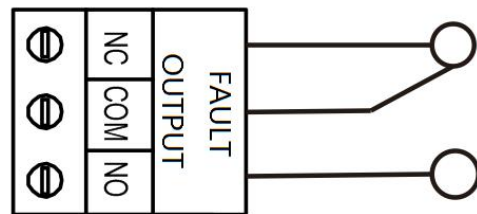

2.3 F.A OUTPUT

This terminal is wiring to other external alarm devices.

This terminal is in normally closed mode under normal conditions, and COM-NC is closed. If there is a fire alarm output, it will switch to the normally open mode and COM-NO will be closed.

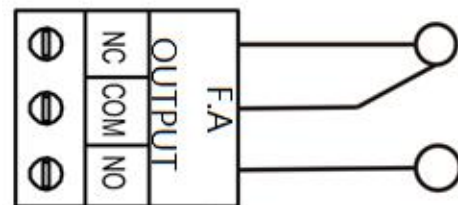

2.4 F.P.E OUTPUT

The terminal output signal of the transmission of fire alarm signals to controls for automatic fire protection equipment.

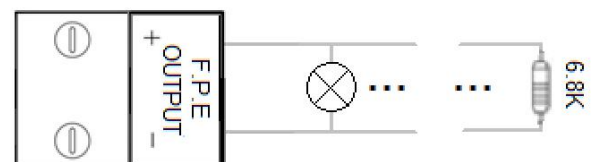

2.5 S.C OUTPUT

This terminal output signal of external conventional alarm bell or strobe lights. Pay attention to the polarity of the terminal when wiring, and paralleled connect a 6.8KΩ/1W resistor in the end of the output circuit.

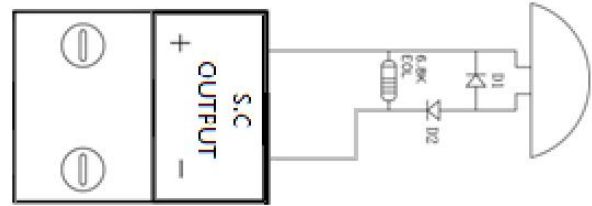

2.6 AUX POWER OUTPUT

This terminal output signal of a resettable 24VDC, which maximum output current is 200mA. Pay attention to the positive and negative of the terminal when wiring.

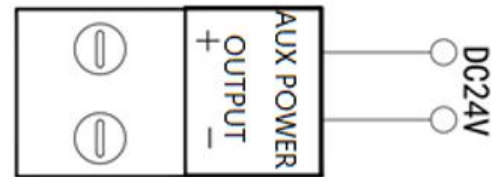

2.7 VOLT FREE INPUT

Reserved

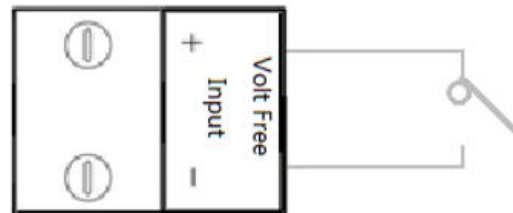

2.8 Loop in and loop out terminal

This terminal wiring to the external devices input and output.

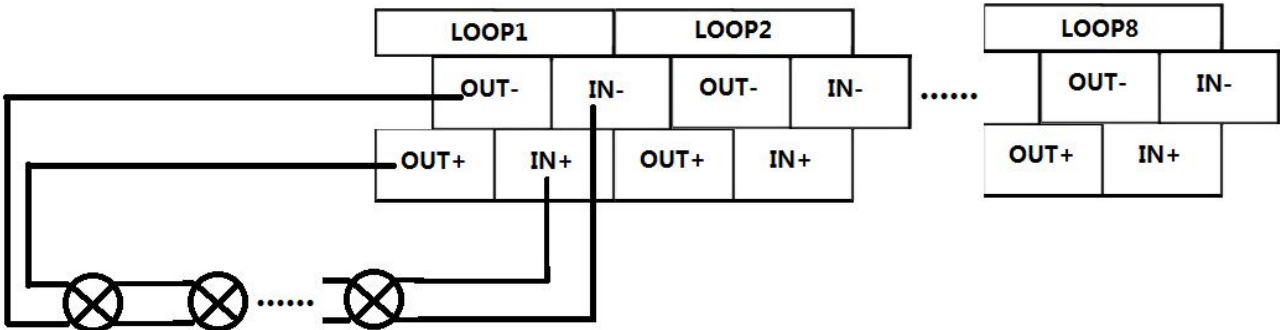

2.9 CAN

This terminal is wiring to connect other panel.

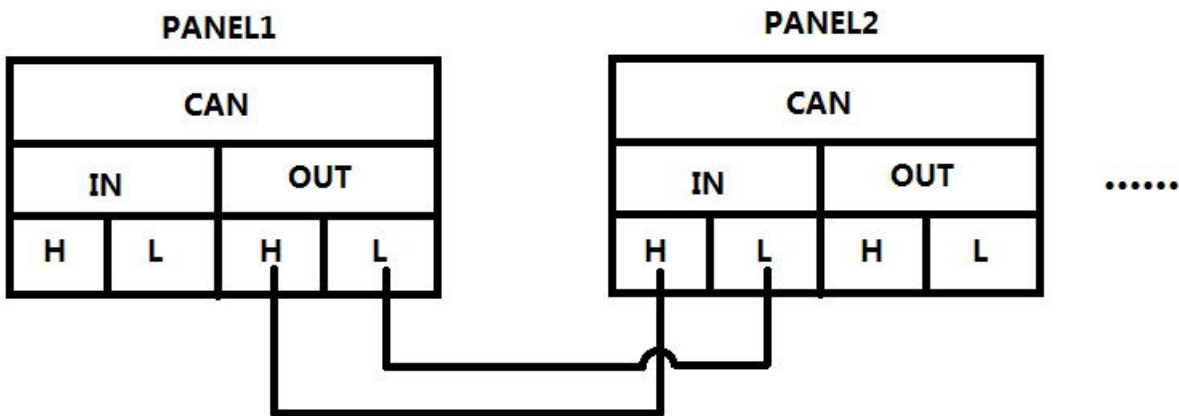

3 Home Screen And Main Menu Description

3.1 Home screen specification

In the normally running of the system, all the display columns on the home screen are empty. As shown in Figure 1, the date, time and access level will be displayed at the bottom of this page.



Figure 1. Home screen under normal running

By touch the menu button on the screen, users can manipulate and view more system content (described in detail in subsequent chapters).

By touch the login (LOGIN) button on the screen, users can enter the system with the corresponding access level password.

By touch the exit button, the user can exit the current access level and return to level 1.

When anything happens, they will be displayed in the event column corresponding to the main screen. For example, the detector sends a fire alarm signal to the control panel, which will be displayed on the Fire page.

Disable information for devices or Zones will be displayed in the Disable column.

When any fault occurs, it will be displayed in the Fault column.

The information when the strobe sounder is activated will be displayed in the Activation column.

Click the corresponding Label to switch pages.

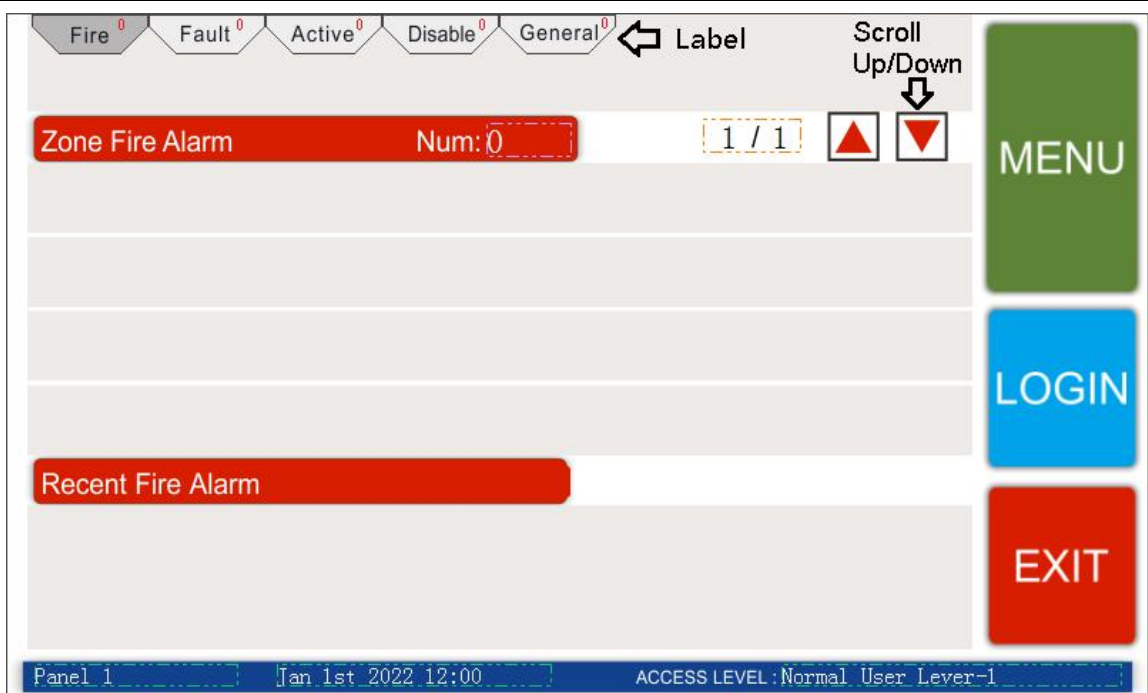

Figure 2 Home screen display

3.2 Main menu specification

Press the menu button in the home screen, users can access the functions of history, panel settings, registration and status operation. Users need to log in before enter the menu, as shown in Figure 3, select the appropriate access level, enter the login password and then enter the system.

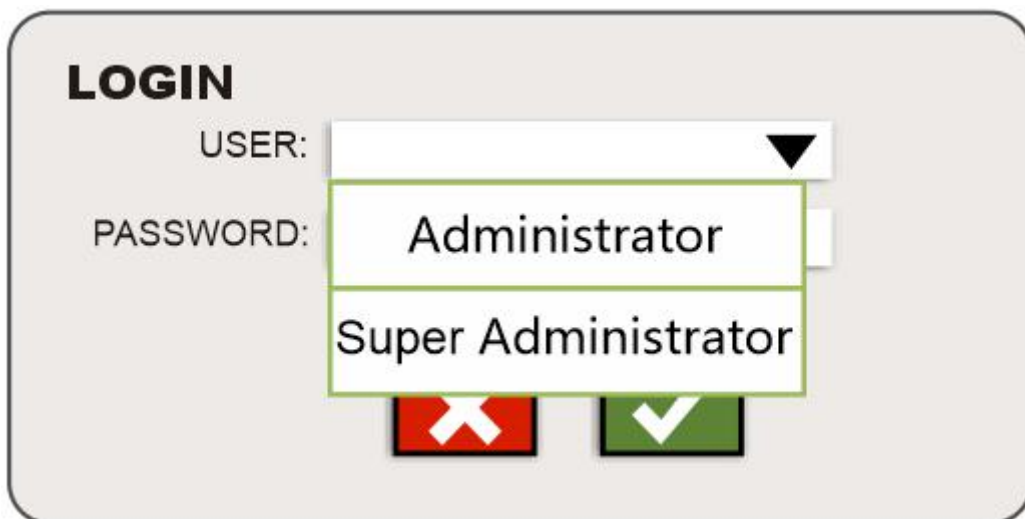

Figure3. Login

Figure 4 shows the display interface after entering the menu, which contains a variety of functional settings and operations. In the main menu interface, it includes password modification, panel settings and other settings.

The access level 2 user corresponding to the Administrator; the user access level 3 corresponding to the Super Administrator.

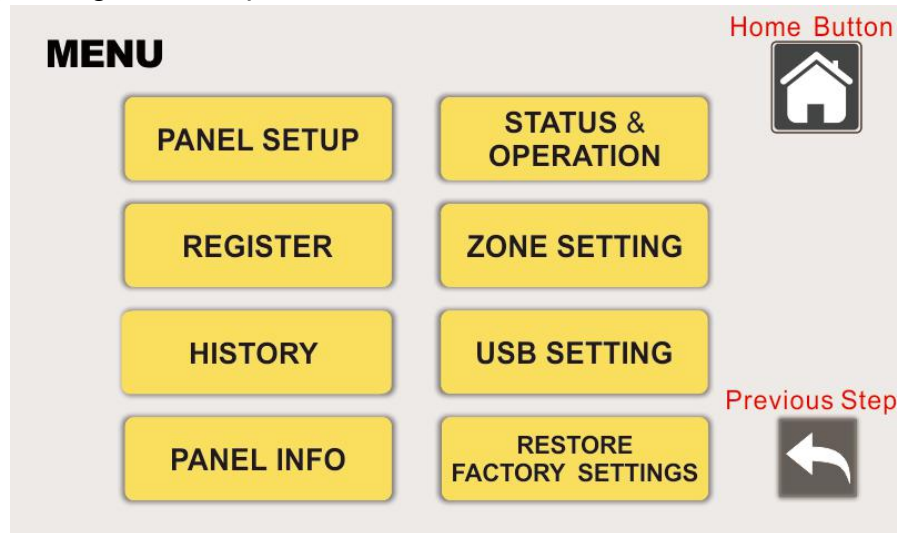

Figure 4 Main menu

- 3.2.1 Home button: Can help users quickly return to the home page.
- 3.2.2 Previous step: To help users return to the previous page.
- 3.2.3 PANEL SETUP: Users can enter seven submenus of Configuration, TCP/IP, CAN, GSM, CHANGE PASSWORD, PRINTER, FAULT BUZZER SHIELD. (see below for details).
- 3.2.4 STATUS & OPERATION: Users can enter two submenus of WIRED DEVICE, WIRELESS DEVICE to check the device status (see below for details).
- 3.2.5 REGISTER: Users can enter two submenus of WIRED DEVICE, WIRELESS DEVICE to register the device (see below for details).
- 3.2.6 ZONE SETTINGS: The user can set the zone in this menu (see below for details).
- 3.2.7 HISTORY: Users can select a history page to view fire alarm history, fault history, linkage history and operation history(see below for details).
- 3.2.8 USB SETTING: Users can enter SETTINGS IMPORT , SETTINGS EXPORT these two submenus to set import and export (see below for details)
- 3.2.9 PANEL INFO: Users can view the settings of the host(see below for details).
- 3.2.10 Restore factory settings: Submenu restore factory settings allows users to restore the control panel to factory settings and reset the panel according to the new configuration.

4 Main menu configuration and operation

Users can configure directly on the control panel to save installation time; easy-to-use software makes it easy for users without experience; press the MENU button on the main screen to enter other functions.

4.1 The suggestion before configuration

Before configuring, it is highly recommended to follow the procedure below to prevent errors that may cause reconfiguration.

- 4.1.1 Make a record sheet to get the exact information for all devices, repeaters and Zones. Carefully assign addresses to all devices.
- 4.1.2 Assemble and power the panel to check that all boards are securely installed;
- 4.1.3 Please read this manual before configuration.
- 4.1.4 Change the passwords of the administrator and super administrator.
- 4.1.5 Configure all devices and test the system. Testing can be done point-to-point using test methods, as described in subsequent chapters of this chapter.
- 4.1.6 Save the original configuration with the hard disk.



ASENWARE LTD

Website: www.asenware.com

Email: info@asenware.com

Manufacturer: **Zhongshan Guta Fire Equipment Technology Co.,Ltd**

Add: 4/F,#10,Xingye Rd, Huoju District Zhongshan City,Guangdong P.R. China

5 PANEL SETUP

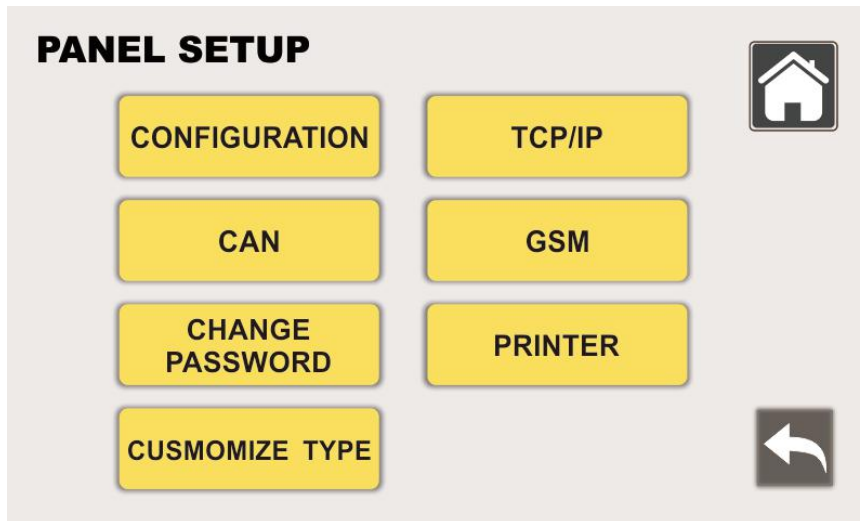

5.1 CONFIGURATION

Press the Configuration button, the user can modify the switch of the loop, set the time and set the screen save.

Only Level 3 and Level 4 users can modify Configuration.

LOOPS: Select the opening and closing of the Loops.

SCREEN SAVER: You can adjust the screen saver time (maximum 250 seconds, set 0 to not turn off the screen), when the set time is not active, the screen will go to sleep to protect the LCD screen.

TIME SETUP: Set the clock on the panel.

Shown in the figure 5 below.

When all settings are complete, save these changes by pressing the green “√” in the lower right corner of the window.

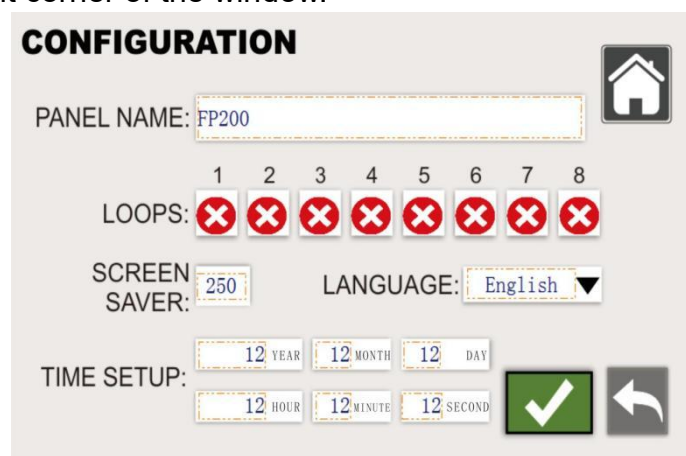

Figure 5.Configuration



ASENWARE LTD

Website: www.asenware.com

Email: info@asenware.com

Manufacturer: **Zhongshan Guta Fire Equipment Technology Co.,Ltd**

Add: 4/F,#10,Xingye Rd, Huoju District Zhongshan City,Guangdong P.R. China

5.2 TCP/IP

Figure 6.TCP/IP SETTING

The ASENWARE AW-FP100 Series can be connected over a network, using IP addresses and DNS server settings to establish network communications.

The user must fill in the information in the TCP/IP address of the submenu. After filling in, click the green “√” in the lower right corner of the page to save the settings. As shown in Figure 6.

TCP CLIENT is used to connect to the standard TCP Modbus protocol software; TCP SERVER is used to connect to ASENWARE's LAN software; CLOUD is used to connect to the ASENWARE cloud.

NOTE: Net Enable"ON"to turn on this function,"OFF"to turn off this function

NOTE: The panel contains three ports, each of which runs independently.



5.3 CAN

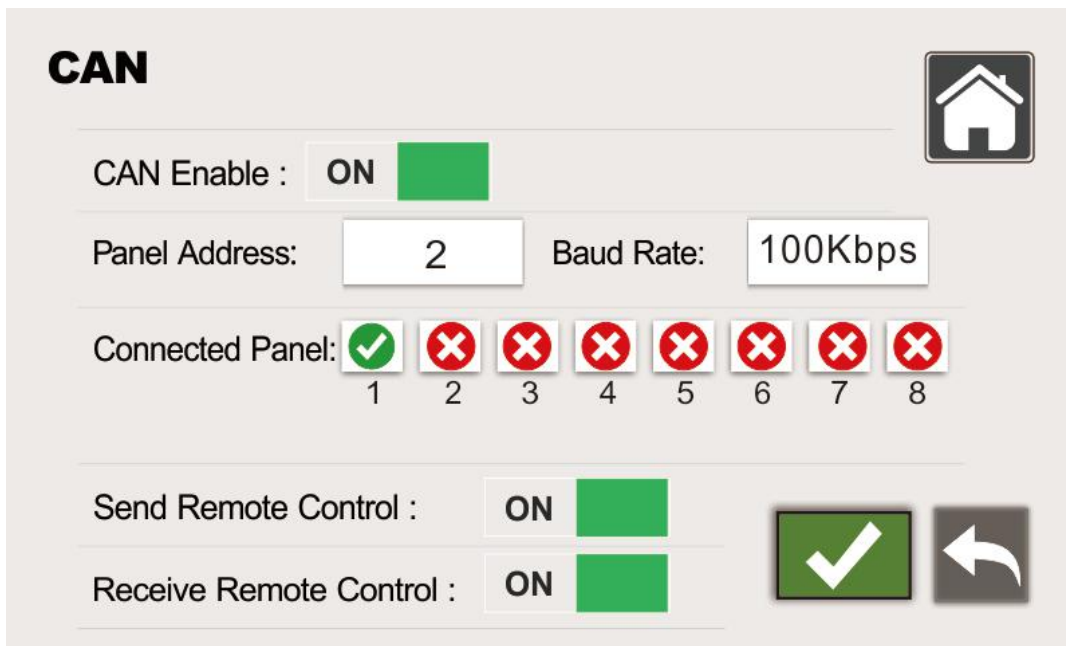

Figure 7.CAN

CAN is used for mutual communication between different Panels.

CAN Enable: CAN function switch.'On' for 'Enable; 'Off' for Disable.

Panel Address: Set the panel number to identify different panels

Baud Rate: Modify the transfer rate to suit the usage environment, All the panel in the same system need to set the same rate.

Connected Panel: To connect other panels, mark the number of the panel to be connected as “√”. Do not check the panel number that is the same as the panel address.

Send Remote Control: Send reset, mute and other control commands to other panels.'On' for 'Enable; 'Off' for Disable.

Receive Remote control: This panel accepts control commands from other panels. 'On' for 'Enable; 'Off' for Disable.



ASENWARE LTD

Website: www.asenware.com

Email: info@asenware.com

Manufacturer: **Zhongshan Guta Fire Equipment Technology Co.,Ltd**

Add: 4/F,#10,Xingye Rd, Huoju District Zhongshan City,Guangdong P.R. China

5.4 GSM

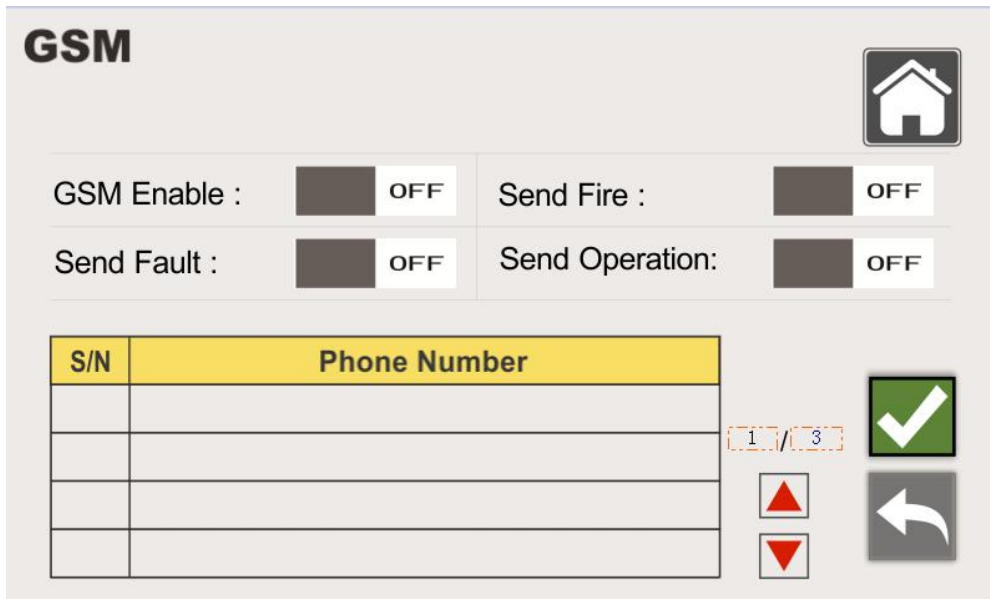

S/N	Phone Number

Figure 8.GSM

In this GSM setup window, referring to Figure 8, the user can fill in the mobile phone number of the authorized person to send the alarm information of the panel to the designated person's mobile phone by means of short message. After filling in, click the green “√” in the lower right corner of the page to save the settings.

5.5 CHANGE PASSWORD

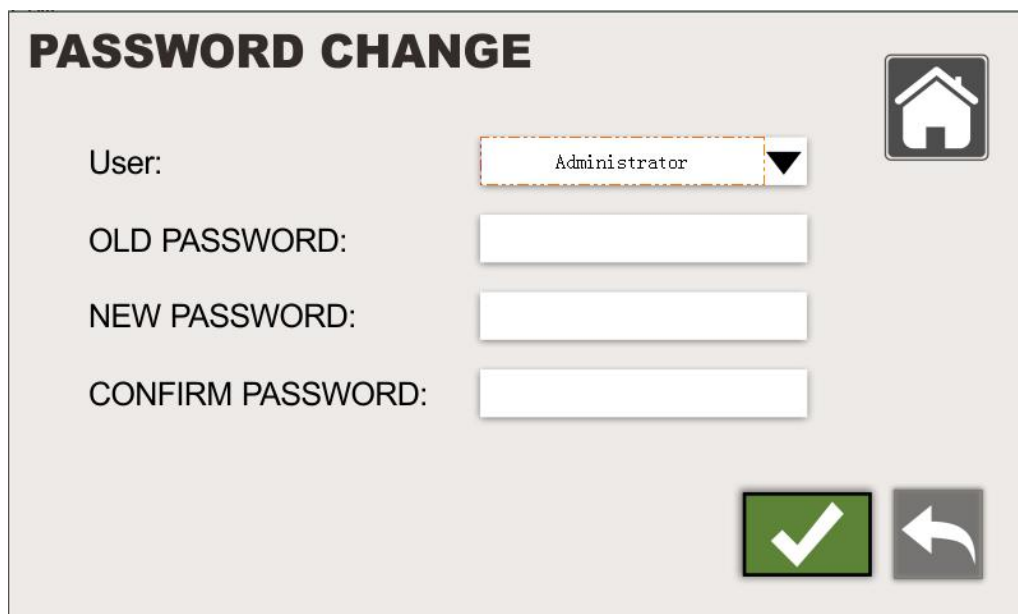

Figure 9.Change password

Press the PASSWORD CHANGE button, the user can change the password for login. The passwords for access level 2 and access level 3 can be modified through the interface shown in the figure 8 below.

The access level 2 user corresponding to the Administrator; the user access level 3 corresponding to the Super Administrator.

Developer is a user of access level 4, and only the manufacturer and the person trained by the manufacturer to change or modify the system can be authorized to access this level.

There are usually two levels of passwords: administrator and super administrator. According to the EN 54-2 standard, an administrator is called a level 2 user, and a super administrator is called a level 3 user. The super administrator can modify the configuration and register the panel.

When the control panel is shipped from the factory, the password is set to: administrator password "1111" and super administrator "1111". Users need to modify the product after receiving the product.

Note: Passwords are all Arabic numerals and are 4 in length. After making all the changes to the password, click "√" to save it.

Incorrect password or forgotten password .

If the entered password is incorrect, the panel will display "Password Error". After exit this window, you can re-enter your password. If the user forgets the password, the access level 4 can restore it to the initial password in the user list. How to do this will be explained in the following sections.

Note: The user must click "√" to confirm the change.



ASENWARE LTD

Website: www.asenware.com

Email: info@asenware.com

Manufacturer: **Zhongshan Guta Fire Equipment Technology Co.,Ltd**

Add: 4/F,#10,Xingye Rd, Huoju District Zhongshan City,Guangdong P.R. China

5.6 PRINTER

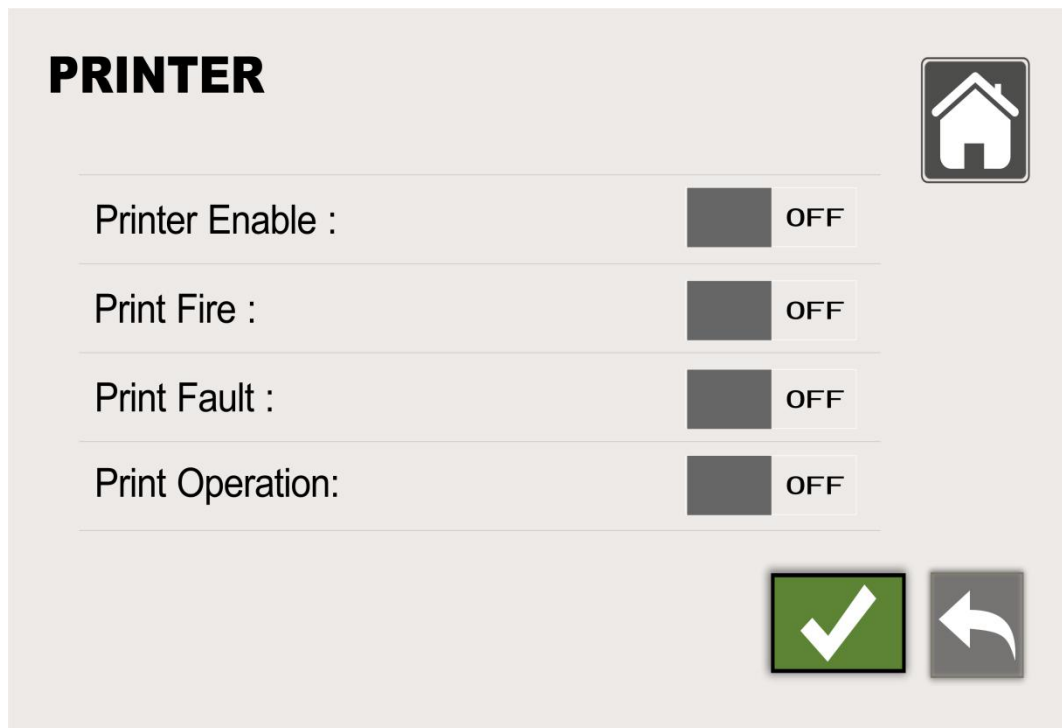

PRINTER

Printer Enable : OFF

Print Fire : OFF

Print Fault : OFF

Print Operation: OFF

Figure 10.Printer

In the print setting window, as shown in Figure 10, set whether to enable the print module and set Fire, Fault and Operation information respectively. OFF means not disabled, ON means disabled.

Note: The user must click "✓" to confirm the change.

5.7 Customize Type

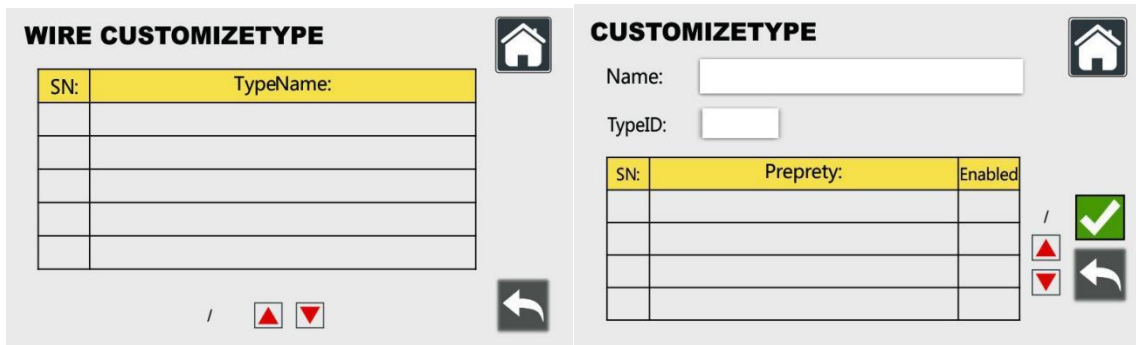

Figure 11.CUSTOMIZE TYPE

When new products are released, users can add device types to adapt. Detailed usage methods will be provided when new products are released.

Note: The user must click "√" to confirm the change.

5.8 Panel Fault Shield

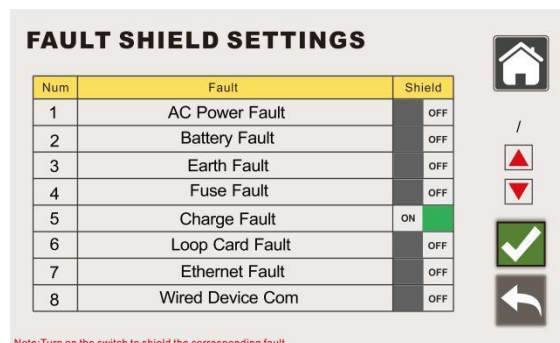

Figure 12. FAULT SHIELD SETTINGS

The fault shield interface can shield a certain fault of the panel, and the shielded fault will not trigger an alarm, nor will it be showed.

Note: The user must click "√" to confirm the change.

STATUS & OPERATION

6.1 WIRED DEVICE

WIRED STATUS

Loop:

Addr	Device	Location	Status	Test	Disable
1	supervisory module-normal		Normal	<input type="checkbox"/> OFF	<input type="checkbox"/> OFF
			Fault	<input type="checkbox"/> OFF	<input type="checkbox"/> OFF
				<input type="checkbox"/> OFF	<input type="checkbox"/> OFF
				<input type="checkbox"/> OFF	<input type="checkbox"/> OFF
				<input type="checkbox"/> OFF	<input type="checkbox"/> OFF
				<input type="checkbox"/> OFF	<input type="checkbox"/> OFF
				<input type="checkbox"/> OFF	<input type="checkbox"/> OFF
				<input type="checkbox"/> OFF	<input type="checkbox"/> OFF
				<input type="checkbox"/> OFF	<input type="checkbox"/> OFF
				<input type="checkbox"/> OFF	<input type="checkbox"/> OFF
				<input type="checkbox"/> OFF	<input type="checkbox"/> OFF
				<input type="checkbox"/> OFF	<input type="checkbox"/> OFF
				<input type="checkbox"/> OFF	<input type="checkbox"/> OFF

Page: GO

 /
▲
▼

✓
↶

Figure 12. WIRE STATUS

This page displays the operating status of each wired device. LOOP selects the corresponding Loop, Addr is the address, Device is the device type, Location is the registered location, and Status is the current Normal or Fault status of the device. Test can make the corresponding device enter the test mode. Disable enables the corresponding device to be disabled.



6.2 WIRELESS DEVICE

WIRELESS STATUS 						
Group	Addr	Device	Location	Status	Test	Disable
1	1	supervisory module-normal	0123456789012345	Normal	<input type="checkbox"/> OFF	<input type="checkbox"/> OFF
				Fault	<input type="checkbox"/> OFF	<input type="checkbox"/> OFF
					<input type="checkbox"/> OFF	<input type="checkbox"/> OFF
					<input type="checkbox"/> OFF	<input type="checkbox"/> OFF
					<input type="checkbox"/> OFF	<input type="checkbox"/> OFF
					<input type="checkbox"/> OFF	<input type="checkbox"/> OFF
					<input type="checkbox"/> OFF	<input type="checkbox"/> OFF
					<input type="checkbox"/> OFF	<input type="checkbox"/> OFF
					<input type="checkbox"/> OFF	<input type="checkbox"/> OFF
					<input type="checkbox"/> OFF	<input type="checkbox"/> OFF
					<input type="checkbox"/> OFF	<input type="checkbox"/> OFF

Page: /

Figure 13. WIRELESS STATUS

Group is the device grouping, the rest are consistent with 6.1 In the sub-menu of Panel Setup, the user can view the status of the zone according to the settings performed (see the registration section below).

Note: The user must click "√" to confirm the change.

7.2 WIRELESS LIST

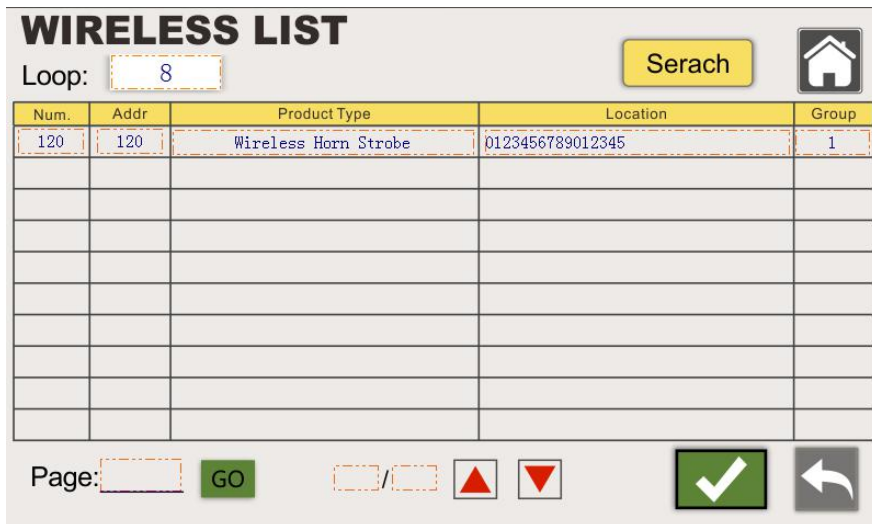

Figure 15 WIRELESS LIST

In this interface, the user can enter the address of the Wireless Horn Strobe registered in WIRED REGISTER, and then click Product Type to enter the WIRELESS REGISTER to set the Wireless Horn Strobe.

7.3 WIRELESS REGISTER

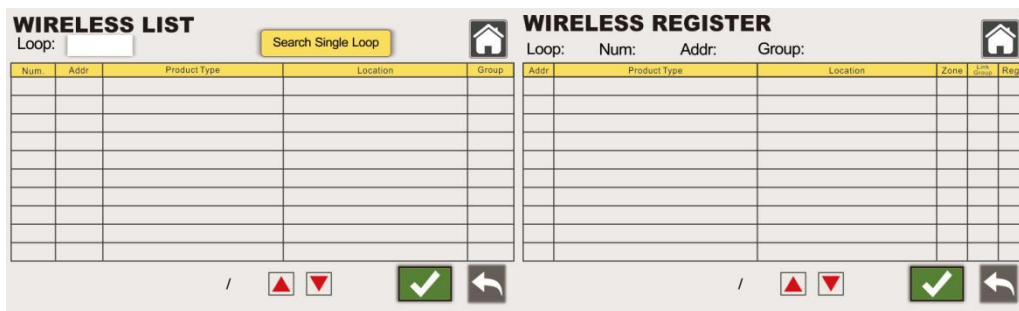

Figure 16. WIRELESS REGISTER

Click Product Type to select the detector type. Each loop can have up to 10 Wireless Horn Strobes, and each Wireless Horn Strobe can have up to 20 wireless detectors.

- 1) Register Wireless Horn Strobe in wired register.
- 2) Click 'Search Single Loop' to get Wireless Horn Strobe List.

3)Set the group of Wireless Horn Strobe. The group is the same as the device set.

4)Click 'Save', and then click 'Product Type' to enter wireless register page to add detectors.



ASENWARE LTD

Website: www.asenware.com

Email: info@asenware.com

Manufacturer: **Zhongshan Guta Fire Equipment Technology Co.,Ltd**

Add: 4/F,#10,Xingye Rd, Huoju District Zhongshan City,Guangdong P.R. China

7 ZONE SETTINGS

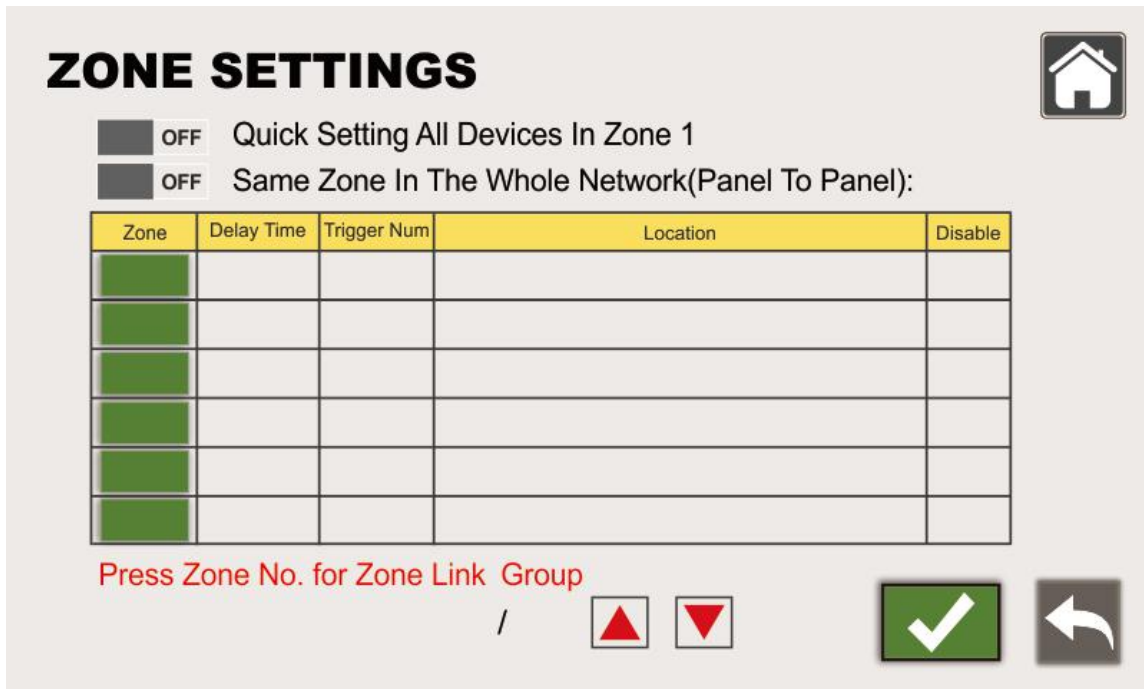

Figure 17. ZONE SETTINGS



Figure 18. Zone Link Group

Quick Setting All Devices In Zone1: All devices in Zone1

Same Zone In The Whole Network: Link Other Panel By CAN.



ASENWARE LTD

Website: www.asenware.com

Email: info@asenware.com

Manufacturer: **Zhongshan Guta Fire Equipment Technology Co.,Ltd**

Add: 4/F,#10,Xingye Rd, Huoju District Zhongshan City,Guangdong P.R. China

Zone: Zone Number.

Delay Time: Activate output devices after this time when fire occur.

Trigger Num: The output devices will activate after alarm devices reaches this number.

Location: Zone Location.

Disable: Disable the zone and devices in this zone.

Zone link Group: Each zone can be link to 120 group for more personalized linkage. If zone fire, it will search the linked group, and activate all the output devices in that group. Press 'Zone Num' to set the link as Figure 18.

Linkage case:

There are 3 MCPs and 3 Bells, and the setting as the form below

Devices	Zone	Link Group
MCP1	1	
MCP2	2	
MCP3	3	
Bell1		1
Bell2		2
Bell3		3

Link Setting		
Zone1	Link	Group1
Zone2	Link	Group1,3
Zone3	Link	Group1,2,3

- 1.MCP1 Fire Alarm → Zone1 Fire Alarm → Group1 Active → Bell1 Active
- 2.MCP2 Fire Alarm → Zone2 Fire Alarm → Group1,3 Active → Bell1,3 Active
- 3.MCP3 Fire Alarm → Zone3 Fire Alarm → Group1,2,3 Active → Bell1,2,3 Active



ASENWARE LTD

Website: www.asenware.com

Email: info@asenware.com

Manufacturer: **Zhongshan Guta Fire Equipment Technology Co.,Ltd**

Add: 4/F,#10,Xingye Rd, Huoju District Zhongshan City,Guangdong P.R. China

8 HISTORY

Users can select a history page to view. As shown in Figure 18, there are four kinds of historical records that can be queried. Users can choose the one they want to view to enter the record storage page.

Note: The Clear History function can only be operated by users with access level 4.

9.1 Fire alarm history: Up to 999 data can be stored, and the latest fire alarm record will appear at the top. As shown in Figure 19, this record contains a detailed description of the fire and the rest.

9.2 Fault history: Up to 999 data can be stored, and the latest fault record will appear at the top.

9.3 Linkage history: Up to 999 pieces of data can be stored, and the latest linked record will appear at the top. It records the activation time of each output device.

9.4 Operation history: Up to 999 pieces of data can be stored, and the latest operation record is displayed at the top. It records the time of each reset, muting, etc.



Figure 19. History

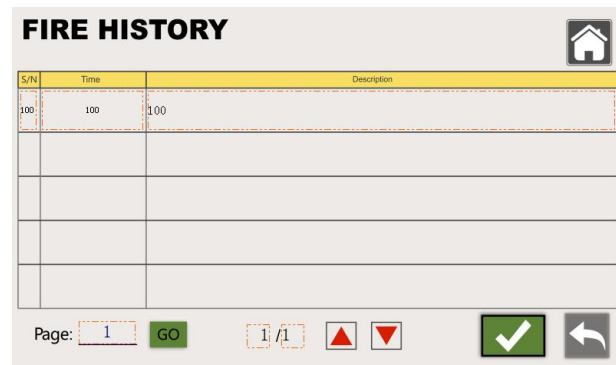

Figure 20. Fire History

9 USB SETTING

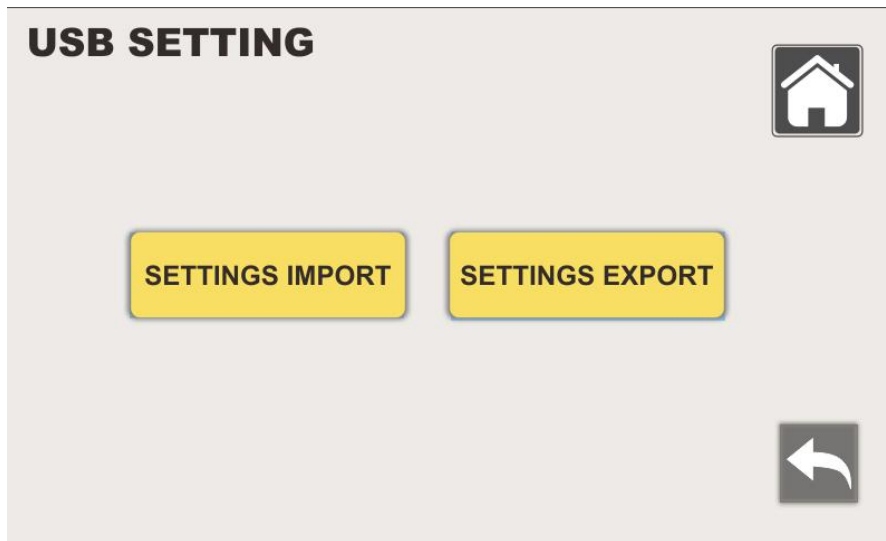



Figure 21.USB SETTING

1. Level 3 and level 4 users can use the Type-C cable and software to configure and produce a DAT file, which can be imported into the upper panel computer software. Or use the upper panel computer software to export the DAT file, and then use the Type-C cable and software to download it to the panel computer. As shown in Figure 21, 'SETTINGS IMPORT' is to download the DAT configuration to the panel, 'SETTINGS EXPORT' is to save the configuration to the DAT file.
2. **SETTINGS IMPORT:** Connect the main board to the PC through the Type-C cable, open the configuration transmission software on the PC side and select 115200 for the transmission baud rate, select the configuration file .DAT in the file sending column of the software, click the software to send, and press **SETTINGS IMPORT**, the configuration can be imported.
3. **SETTINGS EXPORT:** Connect the main board to the PC through the Type-C cable, open the configuration transmission software on the PC side and select 115200 for the transmission baud rate, select the path to save the configuration file in the file receiving column of the software, click the software to receive, and click **SETTINGS EXPORT** on the panel to export the panel configuration and generate a .DAT file.

10 PANEL INFO

If level 2 and access level 3) forgets the password, the submenu user list can help them retrieve the password or change the password. Each user level can only modify its own level of password or subordinate password. As shown in Figure 22, users of access level 4 can see passwords of all levels.

PANEL INFO



Level	Name	Password
Level 1	Normal User	None
Level 2	Administrator	1111
Level 3	Super Administrator	1111
Level 4	Programmer	*****

Type	Hardware Version	Software Version
Main Board	V10	V10
IB Board	V10	None
Loop Card	V10	V10
GSM	V10	V10
Ethernet	V10	V10

SN	1791000000	Default Password	*****
----	------------	------------------	-------





Figure 22 User Info

11 RESTORE FACTORY SETTINGS

Submenu restore to factory settings allows the user to restore the panel to factory settings and reset the panel according to the new configuration. This submenu is only available to users with access level 4.

12 Maintenance

- 13.1 The control panel should be dry and well grounded.
- 13.2 If the control panel gets dirty, wipe it with a dry cloth. Do not use detergent or solvent to clean the panel. Make sure that water does not enter the chassis.
- 13.3 System testing can only be carried out by trained personnel and appropriate isolation measures must be taken to avoid accidental losses.
- 13.4 Please inform all personnel in the area in advance before starting the test.
- 13.5 Care should be taken before removing any cables.
- 13.6 The battery should be inspected regularly and replaced at least every three years.

13 Installation information

Installer: _____ Company: _____

Tel: _____ Add: _____

Date: _____ Serial No.: _____



ASENWARE LTD

Website: www.asenware.com

Email: info@asenware.com

Manufacturer: **Zhongshan Guta Fire Equipment Technology Co.,Ltd**

Add: 4/F,#10,Xingye Rd, Huoju District Zhongshan City,Guangdong P.R. China